



P19 IGLOO

Recoil Compressor

Preface

At Pulsar Modular, every design is a reflection of my deep appreciation for the natural world and our constant adaptation within it—expressed through both form and sound. The P19 IGLOO recoil compressor draws inspiration from one of nature’s most ingenious shelters: the igloo. Built to endure the harshest environments, it represents resilience, efficiency, and precision—qualities that guided the creation of this compressor.

At the heart of P19 IGLOO is the concept of recoil compression, a novel approach that defines its unique sonic signature. As gain reduction increases, the circuit applies a reactive force—a “recoil”—that helps preserve punch and energy. The result is dynamic control with a distinctly analog feel: compressed signals that retain their impact, clarity, and musicality, even under heavy processing.

While our flagship P11 Abyss excels as an RMS compressor—favoring smooth, musical leveling—P19 IGLOO operates as a peak compressor, reacting instantly to transients and bringing a sharper, more immediate contour to dynamic material. The two are designed to complement each other: where Abyss brings depth and warmth, IGLOO delivers precision and presence. Together, they offer a holistic dynamic shaping toolkit, adaptable to any source or production style.

P19 IGLOO was designed to strike a balance between accessibility and depth. Its stepped controls allow for intuitive adjustments, while advanced parameters open doors to precise shaping and bold creative exploration. Though the original vision leaned toward saturated, gritty textures, the final design evolved to include a versatile tonal palette—capable of everything from clean, transparent compression to expansive, character-rich coloration.

Several innovative circuits were developed from the ground up to bring this vision to life. I needed them to produce the spectrum of sounds I already heard in my head. As Michelangelo once said, “The sculpture is already complete within the marble block before I start my work. It is already there; I just have to chisel away the superfluous material.”

— Ziad Sidawi
Audio Equipment Designer & CEO
Pulsar Novation LTD



FULL MODE—Bright Theme

THRESHOLD: Sets the level at which compression engages.

ATTACK: Controls how quickly compression starts after the threshold is exceeded.

RELEASE: Sets the time to fully recover after the signal falls below the threshold.

INPUT: Gain stage the signal entering the input transformer but NOT the S/C signal.

Step mode: Switches the Attack & Release sliders to continuous mode.

BIAS: Transformer biasing.

OVERLOAD: Hyper-compression for truly unexpected results.

S/C HPF: 2-pole internal sidechain high-pass filter.
FEEL: Changes the behavior of the S/C HPF.

SOUL: Device signature sound (ON) or pristine digital state (OFF).

AHEAD (lookahead): Analyzes the input signal buffer ahead of time to better handle transient information.

PSI (pressure): Alters the compression behavior reminiscent of FET, VCA, diode, Vari-Mu and other architectures.

LINK: Stepped or continuous value of the % link of the L&R channels.

RATIO: Adjusts the amount of gain reduction applied above the threshold.

KNEE: Affects the shape of the transfer curve at the point of compression.

Switches the GUI from FULL to EASY mode.

Theme: Bright/Dark mode

DYNAMICS: Adjusts sensitivity to sudden peaks for more natural compression without pumping.



MAKEUP: Adjusts the output level to compensate for gain changes from compression.

MIX: Blends the processed signal with the raw input signal.

TRIM OUT: Adjusts clean output gain as the final stage (post-MIX).

FEEL: Applies to the RATIO for an alternative feel.

Saves the size & position of the current instance.

Peak detection topology

Hold the shift key when adjusting the INPUT IN to compensate equally with the MAKEUP knob.

EASY MODE—Bright Theme

EASY mode simplifies the interface by hiding advanced parameters—such as Dynamics, Soul, Ahead, and channel linking—while keeping them active under the hood, offering a streamlined experience that feels instantly familiar.



EASY MODE—Dark Theme



THRESHOLD: Defines the signal level at which the compressor begins to reduce gain. The detector circuit is always listening to the sidechain (internal or external).

The internal sidechain signal is made up of the input RAW signal + S/C HPF + Trim IN.

RATIO: Sets the amount of compression applied when the input signal exceeds the threshold. A higher ratio increases the compression effect. For example, a ratio of 4:1 means that for every 4 dB above the threshold, the output increases by only 1 dB.

Suggested ratio settings:

- 1.5:1 applies subtle compression for gentle, transparent dynamic control that preserves natural peaks and valleys.
- 2.5:1 applies light/moderate compression for slightly more aggressive but still natural transient control while retaining natural dynamics.
- 4:1 applies medium compression for tighter control, adding punch, subtle tonal changes and loudness.
- 7:1 applies medium/heavy compression, ideal for percussive instruments.
- 10:1 applies heavy compression to aggressively reduce the dynamic range, which may result in reduced clarity and presence if pushed hard.
- 20:1 and 40:1 apply limiting for dramatic effect, creating movement and intense coloration.

FEEL (RATIO): Introduces an alternative rhythmic or dynamic groove to the set ratio.

Compressor parameters often work in tandem. For best results, adjust them in context rather than in isolation. Understanding how attack, release, ratio, knee, and PSI interact will help you shape dynamics more effectively and intuitively.

KNEE: Controls the shape of the transfer curve, smoothing the transition between uncompressed audio below the threshold and compressed audio above it. A low knee setting creates a “hard knee,” resulting in an abrupt transition, while a high knee setting creates a “soft knee,” providing a gradual, smooth transition between the uncompressed and compressed states.

PSI (Psychoacoustic Shaping Index): A unique circuit first introduced in the P11 Abyss. PSI dynamically shapes the internal behavior of the compression process—subtly altering how energy, transients, and harmonics are preserved or emphasized. It’s designed to evoke the *feel* and *tonal vibe* of various compression styles—like VCA, optical, diode bridge, or Vari-Mu. At low PSI values, IGLOO behaves more like a clean, precise VCA-style compressor delivering fast and transparent control with minimal coloration. At higher PSI values, it leans into richer, more colored responses—closer to the saturation, bloom, and harmonic complexity of diode bridge or vari-mu designs. PSI doesn’t directly control time constants or saturation knobs—instead, it guides how the compressor *reacts* and *feels* dynamically. It’s like adjusting the “attitude” of the compression.

To find the ideal PSI setting, close your eyes and listen. Adjust the knob until the compression and saturation feel just right—let your ears guide you, not the numbers.

ATTACK: Controls how quickly the compressor responds and reduces the gain after the input signal exceeds the threshold.

- Fast attack times cause the compressor to react quickly, tightening performances and making sounds feel snappier. This can help control peaks but may reduce the natural energy or introduce distortion. Fast settings often push sounds slightly back in the mix.
- Slow attack times allow the initial transient of the sound to pass through before compression begins. This preserves punch and can make instruments feel bigger and more aggressive. However, it may also lead to less consistent dynamics.

Attack, release, and knee settings work together to define the compressor’s “reflex”—how quickly and smoothly it responds to changes in signal dynamics.

RELEASE

Controls how quickly the compressor stops reducing gain after the signal falls below the threshold. A fast release returns the signal to normal quickly, while a slow release allows the gain to recover more gradually.

- Fast release times sound natural with light compression and can enhance a sense of energy or movement. However, with heavier gain reduction, they may introduce grit, distortion, or pumping artifacts—sometimes desirable, sometimes not—depending on the material.
- Slow release times smooth out dynamics and provide a sense of stability, often helping elements sit further back in a mix. This setting can sound very natural, especially on vocals or pads, but if set too slow, it may cause the sound to feel static or lifeless by restricting movement.

Step/Continuous Mode

By default, P19 IGL00's release operates in stepped mode, offering a fast, repeatable workflow using timing values carefully curated by designer Ziad Sidawi. For more precise control, you can switch to continuous mode, which allows for fine-tuned adjustments to suit the specific dynamics of your track.



SC HPF (Sidechain High-Pass Filter)

Applies a 2-pole high-pass filter to the compressor's sidechain input, preventing low frequencies from triggering gain reduction. This filter *does not* affect the main audio signal—only how the compressor reacts to it. Use SC HPF to avoid unwanted compression caused by bass-heavy content, like kick drums or sub-bass energy.

FEEL (SC HPF): Modifies the sidechain signal, giving an alternative compression response.



PEAK Mode: Shows the average peak levels for the left and right channels using dedicated input and output needles. Numerical peak values are displayed below the meter for precision.

VU Needles: Represent RMS (average loudness) levels. The blue needle shows the *raw input signal*, while the red needle indicates the *final output signal* after compression.

Peak Indicators: Located on either side of the VU window, these show the *instantaneous peak levels* for the left and right channels, along with a hold value for visual reference.

RAW (Blue Needle)—Displays in RMS the unprocessed signal level entering the plugin.

RAW+IN (White ring)—Displays in RMS the combined level of the raw signal plus any gain added by the Input dial. This makes it easy to monitor your signal before and after input gain adjustments.

GR Reading: The black-colored needle displays the average compression of L&R channels, while the value fields display each channel independently. On the sides, you still see the IN/OUT signal levels with peak hold values.

DYNAMICS: Reduces the compressor’s responsiveness to sudden volume changes. This causes it to feel less reactive or even “lazy,” resulting in smoother and more even compression.

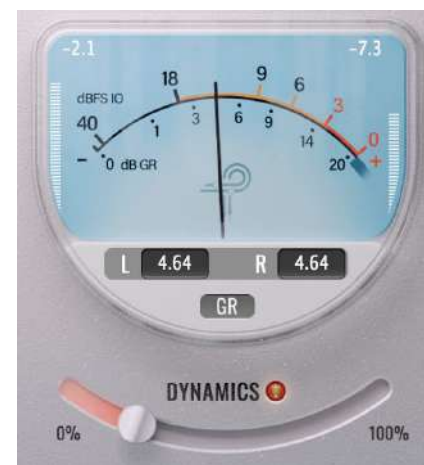

INPUT: Controls the gain feeding the input transformer. Lower settings keep the signal cleaner, while higher settings increase harmonic coloration, shaping the tone before compression. **This gain does not affect the sidechain signal—it’s purely for tone.**

BIAS: Output transformer biasing for coloration of the signal after compression.

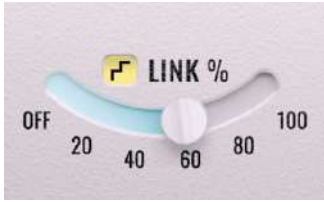

LINK %: Determines how similarly the two sides (L/R) are compressed. At 100%, both channels are compressed equally when the signal on either side exceeds the threshold. At 0%, LINK is disengaged and each channel is compressed independently, simulating two mono compressors. Unlinking can enhance stereo width.

Tip: Unlink the channels to allow independent compression of the left and right signals, which can enhance stereo width. Disable stepping to enter a precise unlink percentage.



SOUL: Toggles between the device's signature analog-inspired sound, delivering a front-to-back depth (ON) or a pristine, digitally clean state (OFF).

AHEAD: Introduces lookahead functionality, allowing the compressor to detect the input signal before processing to better manage initial or sudden transients. This feature requires delay compensation.



MAKEUP: Adjusts the output level to compensate for gain changes introduced by the compression process and TX IN.

MIX: Blends the unprocessed raw DRY signal with the processed WET signal, enabling parallel compression.

OUT (TRIM): Gain stage to balance the signal after the Mix knob has blended the dry & wet.





OVERLOAD: Drives the compression circuit into hypercompression and hardens the sound.

MAKEUP and OUT are clean digital amplifiers and will not color the signal.

  The bypass button allows the unaffected audio signal to flow through without processing.

  Dry polarity inverts the unaffected dry audio signal.

  The external sidechain button enables the use of an external source as the signal feeding the compression detector circuit. Consult the documentation for your DAW for external routing options and instructions.

OS  Oversampling options allow P19 to optionally operate on the saturation, limiter and clipper circuits at double the host sample rate. When OS is off, P19 operates with zero latency at the host sample rate.

VINTG VINTG (vintage) mode operates at double the host sample rate, applying smooth filters to the upper frequencies, creating a classic rolled-off character. It intentionally leaves aliasing signals unfiltered, enabling a blend of vintage smoothness with modern inharmonic distortion.

INTEL INTEL (intelligent) mode operates at double the host sample rate, scanning the full frequency spectrum and attenuating aliasing signals. This advanced filtering heavily depends on the frequency and intensity of the signal.

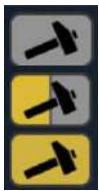

The Hammer circuit functions as a tri-state control with off, half, and full positions. It influences the compression by thickening and flattening the signal, mimicking the action of a traditional hammer.



Hardware Crosstalk enhances stereo separation by introducing the natural, inevitable and inherent analog channel bleeding, resulting in a wider, more open, and more cohesive sound.



The SUB button bypasses the plugin's internal high-pass filter (HPF), which is fixed at 20 Hz. This prevents the filter from attenuating frequencies below the cutoff, preserving sub-bass content that contributes to deep low-end energy. Use this feature to maintain the powerful bass foundation essential in genres like electronic music, hip-hop, or dubstep.

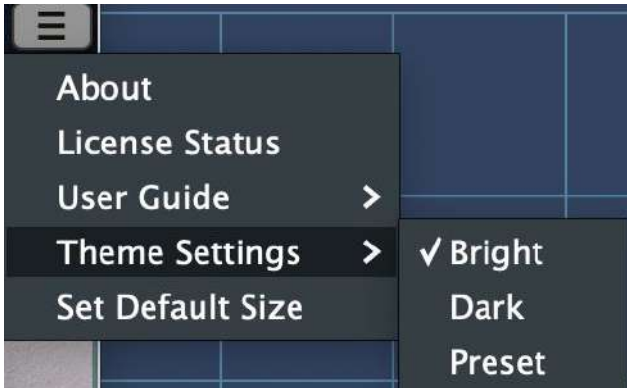

About: Displays the version number and the expiration date.

License Status: Authorize/deauthorize your plugin.

User Guide: Open the user guide.

Set Default Size: This global setting defines the current GUI window size as the default for all new instances.

Theme: Bright and Dark theme is global, while if you choose Preset, then you can save your preferred theme per preset.



A/B enables temporary storage (not stored within the preset) to facilitate quick comparisons between A and B. Click on the A | B area to alternate between the two (no need to move the mouse). The arrow button allows for copying the active side to the inactive side. Presets can also be loaded into either of the A or B placeholders for comparison.



An advanced implementation of the clipper in P44 Magnum is included in P19 Igloo. The clipper's knee can be adjusted from hard to soft.



Igloo features an analog-style brickwall limiter positioned near the end of the signal path, just prior to TRIM OUT.

The limiter prevents the signal from exceeding the THR (threshold) value in dB. Since this is an analog-style limiter, overshoots may occur.

Driving the signal into the limiter produces rich coloration.

THR: Adjusts the threshold ceiling in dB.

RLS: Controls the release time, creating a snappier tone at lower values and a more relaxed response at higher values.

GR: Displays gain reduction metering as numeric values.

The Limiter & Clipper circuits run in zero latency when the OS is off.

The Preset Manager

Favorites Folder

Automatically shows your favorite presets

You can drag and drop presents between the different folders/subfolders/root. Click to load a preset, and double-click to load and close the preset manager window.

Preset Name Field

Displays the currently loaded preset name and opens the Preset Manager when clicked.

Arrow Buttons – Navigate to the previous or next preset within the same folder.

Expand/Collapse Arrow

Opens or closes the folder/subfolder.

Left Panel (Tree View)

Displays folders and subfolders

★ (Active Star)

The preset is also in your favorites.



Right Panel (List View)

Shows presets contained in the selected folder.

Selected Preset

Single-click loads it; double-click loads and closes the Preset Manager.

Close: Close the Preset Manager window.

New Folder: Create a new folder.

Save: Overwrite the selected preset.

Save As: Save current settings as a new preset.

Rename: Change the preset or folder name.

Delete: Remove the selected preset/folder.

Audio Signal Flow

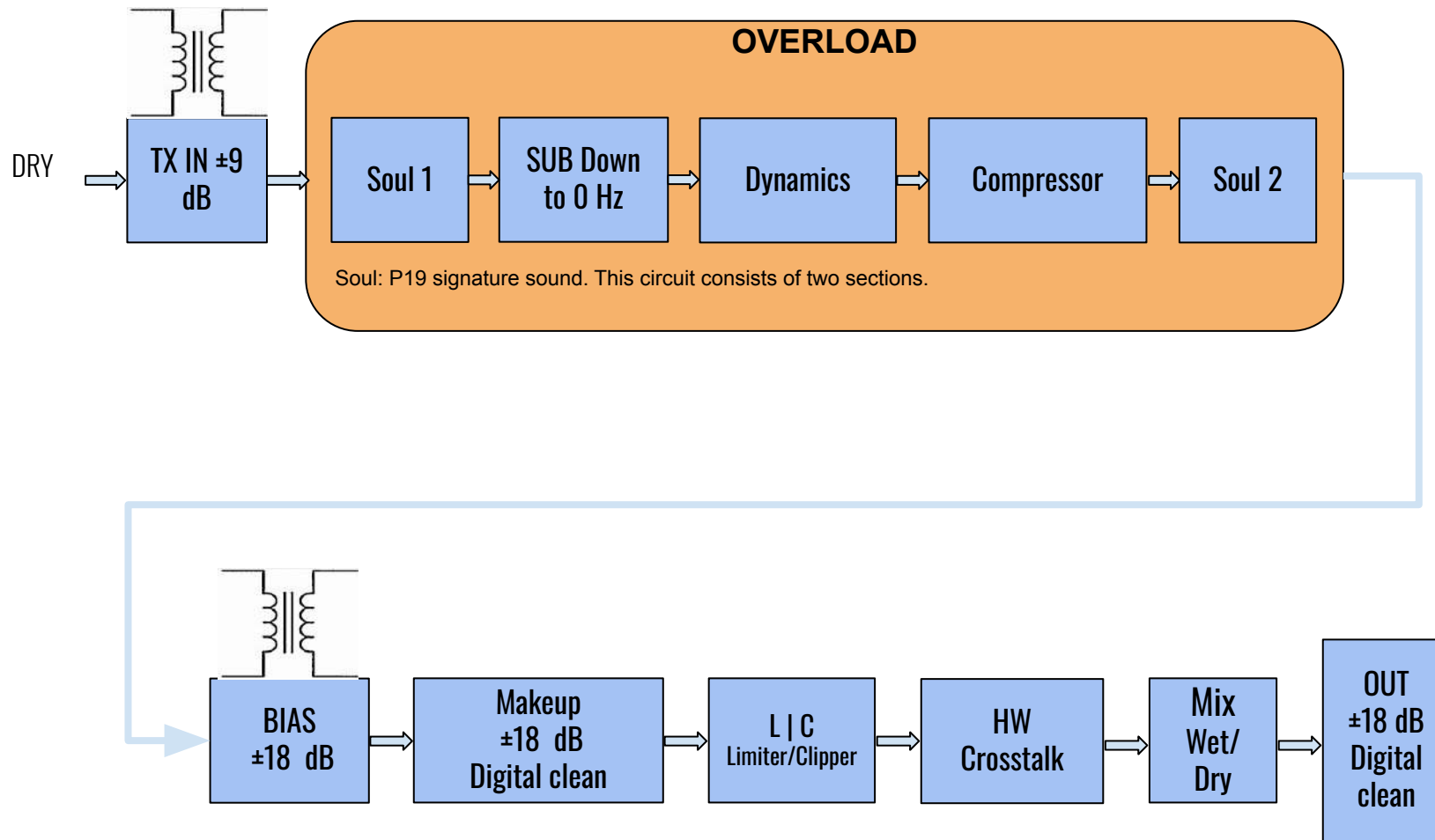

Tips & Tricks

- Even without using the compressor circuit, you can play around with INPUT, BIAS, MAKEUP and OVERLOAD to get transformer saturation, which is another form of compression. Make sure you use the S/C HPF to keep distortion away from the low end.
- You don't always need to push hard into the input transformer. For a wider, more open stereo image, try backing off the Input level — this reduces transformer saturation and preserves spatial detail. Then use the Makeup knob to compensate with clean digital gain. Want even more depth? Try engaging negative BIAS.
- Want to preserve the natural dynamics of a performance—like the subtle nuances in piano? Increase the DYNAMICS slider to reduce compression "breathing" or "pumping." It keeps the compression transparent while letting the performance breathe.
- SOUL, while it delivers front-to-back depth, is not always right for the material at hand, especially now that we work with modern production and sonics.
- Hammer vs. OVERLOAD: think of one thickening while the other is hardening the sound, respectively.
- Working on bass-heavy or low-end-driven music? Enable SUB from the top menu to bypass the internal high-pass filter—letting the full low-end energy pass through untouched.
- Mix Knob=Parallel Dimension: Don't underestimate the MIX knob. Instead of running Igloo fully wet, blend around 70–85% wet for rich transient detail with full body. This approach works especially well on drums, acoustic guitars, or group buses. The dry portion keeps the attack intact, while the compressed path provides weight and polish; it's like parallel compression built in, but perfectly phase-aligned.

- Using PSI as a Tone Shaper: The PSI control is more than a compressor “character” setting; it’s a tone shaper. Lower values yield a transparent, VCA-like behavior; higher values add harmonic complexity and a subtle low-mid bloom, reminiscent of Vari-Mu compression. Try automating PSI across song sections: lower it for intros and verses, then raise it during choruses for a sense of lift and energy.

Use Release Time as Dynamic Automation

You can think of the Release control as a form of dynamic automation instead of simply going for volume automation. By shaping how quickly Igloo recovers after compression, you control the movement and feel of the performance in real time.

For example, on a brass section, try matching the release time to the musical tempo:

- Setting the release around a 16th-note value keeps the section lively and breathing with the rhythm.
- Using a quarter-note release extends the compression, holding the section down slightly and creating a smoother, lower-volume feel.

You can use this concept across different sections of a song:

- In a verse, use a longer release for tighter control and a more intimate, contained sound.
- In a chorus, shorten the release for added punch, excitement, and dynamic lift.

There’s no need to follow tempo divisions too strictly; sometimes the best results come from feeling the release rather than calculating it. Let the groove and phrasing guide your timing; when it feels musical, it’s right.

Modifier keys

Temporarily bypass a parameter

CTRL+ALT (Windows) or CMD+OPTION (macOS) + Mouseover:

- INPUT (defaults to 0).
- BIAS (defaults to 0).
- S/C HPF (defaults to off).
- LINK % (defaults to 100%).
- OVERLOAD (defaults to 0).
- DYNAMICS (defaults to 0%).

Cycle between options

Left-Click for forward, Right-Click for backward.

- HAMMER.
- OS VINTG, INTEL.
- L/C OFF, LMTR, CLIP.

Gain compensate

SHIFT

- INPUT x MAKEUP.

Enable parameters for automation (Pro Tools only)

Control + command + option (⌘ + ⌘ + ⌘) on macOS or CTRL + ALT + START on Windows.

Fine adjustment of knobs, sliders and other controls

Hold control (⌘) on macOS or CTRL on Windows, then click and drag. Alternatively, right-click and drag without a key modifier.

Return controls to their default state

Press option (⌘) on macOS or ALT on Windows and left-click. Alternatively, double-click without a key modifier.

Managing Presets

Installation

If you keep the *Install Presets* option selected during installation, factory presets will be overwritten. Your own presets will remain intact. To keep any edits to factory presets, simply deselect “Install Presets” during updates.

Saving Presets

Use Save As in the Preset Manager to create your own presets. This prevents them from being replaced in future updates. You can also organize presets into folders and subfolders within the Preset Manager.

Your presets are stored here:

- Windows: `C:\Users\Public\Documents\Pulsar Modular\P19 Igloo\Presets`
- macOS: `/Users/Shared/Pulsar Modular/P19 Igloo/Presets`

You can organize, rename, or create folders and subfolders, and all changes will appear automatically in the Preset Manager.

Pro Tools Preset Management

When using P19 Igloo in Avid Pro Tools, note that Pro Tools handles plugin preset management differently from most other DAWs. To ensure P19 Igloo's internal preset system works seamlessly with Pro Tools' own preset management, follow these steps:

1. Set Plugin Default Behavior
 - In the plugin's header bar (top of the plugin window), open the Preset drop-down menu in Pro Tools.
 - Navigate to Settings Preferences → Set Plug-In Default to → User Setting.
 - This ensures that P19 Igloo recalls your most recent or user-defined settings instead of reverting to the factory default every time the plugin is inserted.
2. Save Presets to the Session Folder
 - Again, open the Preset menu and go to Settings Preferences → Save Plug-In Settings to → Session Folder.
 - This ensures all custom P19 Igloo settings are stored within the current Pro Tools session folder, rather than the global root settings directory.
 - This is especially useful when collaborating or moving sessions between systems, as your P19 Igloo settings will automatically travel with the session.

Tip: Enabling both options allows Pro Tools and P19 Igloo's internal preset browser to work hand in hand, ensuring consistent recall and smooth preset workflow across sessions.

Uninstalling P19 IGL00

For Windows

- VST3: 'C:\Program Files\Common Files\VST3\Pulsar Modular', locate the 'P19 Igloo.vst3' folder and delete it.
- AAX: 'C:\Program Files\Common Files\Avid\Audio\Plug-Ins\Pulsar Modular', locate the 'P19 Igloo.aaxplugin' folder and delete it.
- Shared: 'C:\Users\Public\Documents\Pulsar Modular', locate the 'P19 Igloo' folder and delete it. This folder contains the user guide and presets. If no other folders exist under 'Pulsar Modular', this can be deleted as well.

For macOS

- AU: '/Library/Audio/Plug-Ins/Components', locate the 'P19 Igloo.component' file and delete it.
- VST3: '/Library/Audio/Plug-Ins/VST3/Pulsar Modular', locate the 'P19 Igloo.vst3' file and delete it.
- AAX: '/Library/Application Support/Avid/Audio/Plug-Ins/Pulsar Modular', locate the 'P19 Igloo.aaxplugin' folder and delete it.
- Shared: '/Users/Shared/Pulsar Modular', locate the 'P19 Igloo' folder and delete it. This folder contains the user guide and presets. If no other folders exist under 'Pulsar Modular', this can be deleted as well.

Plugin Design: Ziad Sidawi
Plugin Development: Pulsar Modular Team
GUI Development: Max Ponomaryov / azzimov GUI design – www.behance.net/azzimov
User Guide (Content): Kevin Eagles & Ziad Sidawi
User Guide (Layout): Hisham Sidawi
Testers:
Leo Alvarez Clay Blair Mátyás Dobány Kevin Eagles
Gus Granite Jean-Marie Horvat Matthias Klein Bob Rosa
Niklas Silen Brad Smith Marc Smith

Please kindly report any errors or omissions in this user guide to psupport@pulsarmodular.com

Copyright 2026, Pulsar Modular™

P/N: 45469, Rev. 1.0

P19 IGLOO is a plugin name owned by Pulsar Modular™

Restrictions

The USER may not reverse engineer, disassemble, re-sample, create Impulse Response profiles or re-record, decompile, modify, alter in whole or in part PULSAR MODULAR audio plugins for the intent of renting, leasing, distributing, repackaging (whether for profit or not).

AAX and Pro Tools are trademarks of Avid Technology. Names and logos are used with permission.

Audio Units is a trademark of Apple, Inc.

VST is a trademark of Steinberg Media Technologies GmbH.

All other trademarks contained herein are the property of their respective owners.

Pulsar Modular™ is a trademark of Ziad Al Sidawi SPC, Muscat, Oman.

All other trademarks are the property of their respective owners.

Pulsar Modular™

Unit 52, Building 348, Way 5001, Block 250

South Aludhaybah, Bawshar, Muscat

Sultanate of Oman

pulsarmodular.com